

Gemini TA3 Call for Access – P1 2022/23

The following information provides guidance for the Gemini TA3 experimental area for the 2022/23 proposal calls. It is recommended that you discuss your laser and experimental requirements with the appropriate CLF personnel prior to submission of your proposal.

Overview

To maximise scientific output, we would like to operate Gemini TA3 in **one** configuration during the whole period. This allows a common set-up to be arranged at the start to install and test the majority of the apparatus. Experiments with similar layouts will then be scheduled consecutively with a short break between to allow facility access for changeover.

Please contact Gemini staff to clarify any questions about your proposal. We request the applicants to base their experimental set-up on one of layouts described below. Significant deviations from these layouts must be agreed with Gemini staff prior to submission.

Current Gemini specifications

Main Beams: North and South available

- a. Energy: ~12 J on South
 ~ 12 J on North
- b. Pulse length: 40-45 fs,
- c. Beam diameter: 15 cm diameter
- d. Focal spot $1/e^2$ radius: (using adaptive optics-images on the right)
 F/20: 16.7 μ m
 F/2: 1.6 μ m
- e. A close-in contrast scan is shown below.

The contrast parameters are:

- 10^{-10} ASE level (ns)
- 10^{-7} prepulse contrast (ps)
- 10^{-4} at 1ps

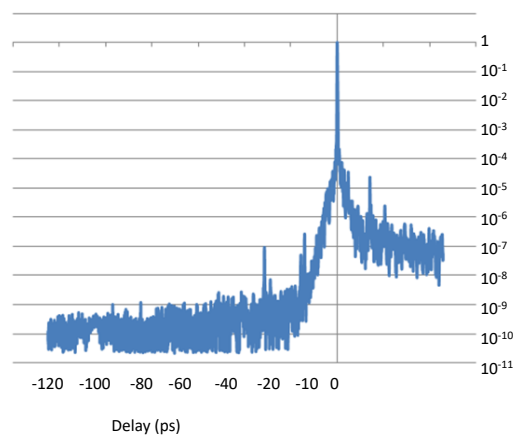
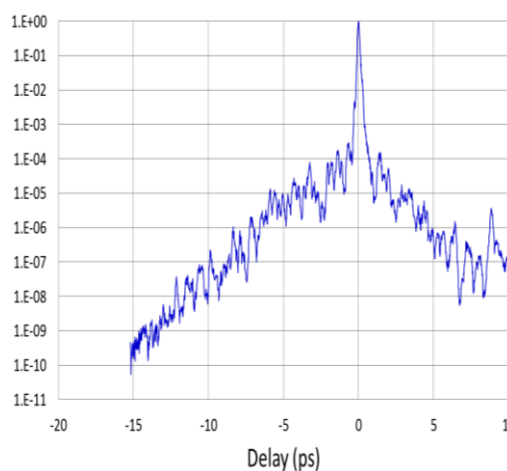
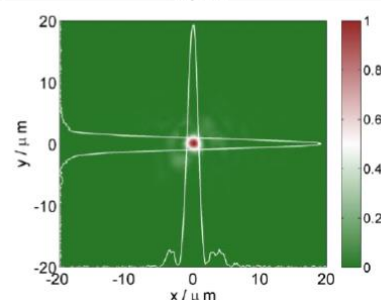
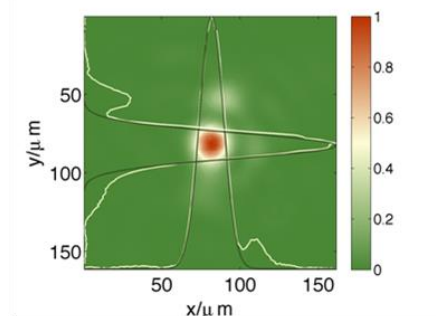

Permanent beam and alignment diagnostics available:

- a. A double plasma mirror system to improve the picosecond contrast to 10^{-6} at 1ps
- b. Long working distance Mitutoyo objective lenses for focal spot imaging
- c. Adaptive optics on both beam lines
- d. Solid target positioning system (based on rear surface illumination)
- e. Input Far field and near fields
- f. Overhead imaging of target chamber centre
- g. Single shot grenouille for pulse length measurement after interaction
- h. All relevant laser parameters displayed on eCAT on a shot-to-shot basis.

Plasma diagnostics available:

- a. Thomson ion spectrometers
- b. Electron spectrometer (inside chamber/outside)
- c. Flat field spectrometer
- d. X-ray crystal spectrometers
- e. X-ray pinhole camera
- f. Optical spectrometers
- g. Solid target reflectivity monitors

Permanent target mounts/drives available:

- a. Wide variety of standard motorised and manual stages
- b. Custom built mounts on request (subject to budgetary constraints)
- c. Thick and thin film target wheel, x-y-z and rotary drives. Holding array targets.
- d. Standard gas jet and gas cell mounts.

Mode of operation:

- a. The main optical layout will be built and tested in setup weeks
- b. All diagnostics, cables etc. will be tested in setup weeks where possible
- c. Weekly system tuning: To ensure reliability of the system during the operations-heavy weeks, we may require up to 50% of a day (preferably Mondays) to tune up the system. All lost hours will be compensated by providing operational support during out-of-office hours.
- d. All non-standard diagnostics need to be discussed and agreed with the concerned CLF staff prior to proposal submission



Feasible Experimental Geometries

Standard experimental geometries are shown below.

Please contact Gemini staff if your proposal has requirements that are not covered by the options outlined here. For other focusing geometries please get in touch with Gemini staff as soon as possible.

PLEASE NOTE: These drawings are indicative. The plasma mirror system is now housed in a separate chamber.

(1) F/20 (South beam) with F/2 (North beam): 120 or 90 degrees between beams.

Diagnostic Location Options

F2 forward options:

Single Thomson Ion Spectrometer (*outside*)
Electron spectrometer (*out or inside*)
Flat field x-ray spectrometer (*outside*)
X-ray crystal spectrometer (*out or inside*)
Pinhole camera (*inside*)

F2 35degree options:

Triple Thomson Ion Spectrometer (30-45deg) (*outside*)
Electron spectrometer (*out or inside*)
Flat field x-ray spectrometer (*outside*)
X-ray crystal spectrometer (*out or inside*)
Pinhole camera (*inside*)

F20 forward options (inside):

(<60 deg range of angle supportable)
Thomson Ion Spectrometer
Compact magnet electron spectrometer
X-ray crystal spectrometer

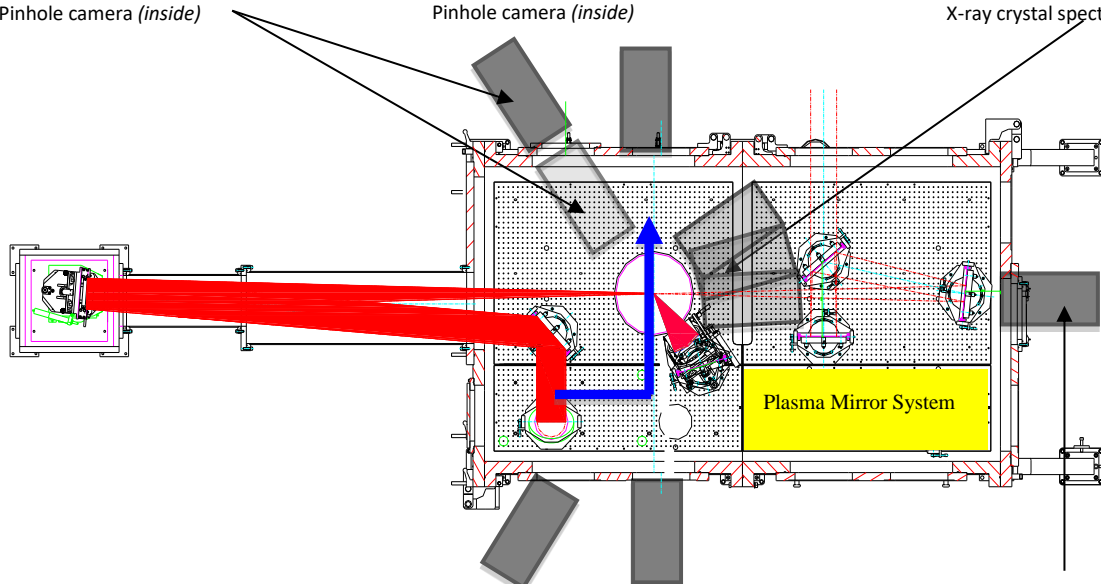

Reflected F2 options:

(outside due to space and F20 beamline)
Thomson Ion Spectrometer
Compact magnet electron spectrometer
Flat-field spectrometer
X-ray crystal spectrometer

Reflected F2 @ 35deg :

(primarily outside due to F2 mount and probe)
Thomson Ion Spectrometer
Compact magnet electron spectrometer
Flat field x-ray spectrometer
X-ray crystal spectrometer
Pinhole camera

F20 forward options (outside):

Thomson Ion Spectrometer
Flat field Spectrometer (single or triple)
Electron spectrometer
X-ray crystal spectrometer
Pinhole camera



Raised level beam transport is shown below to aid planning of out of plane diagnostics.

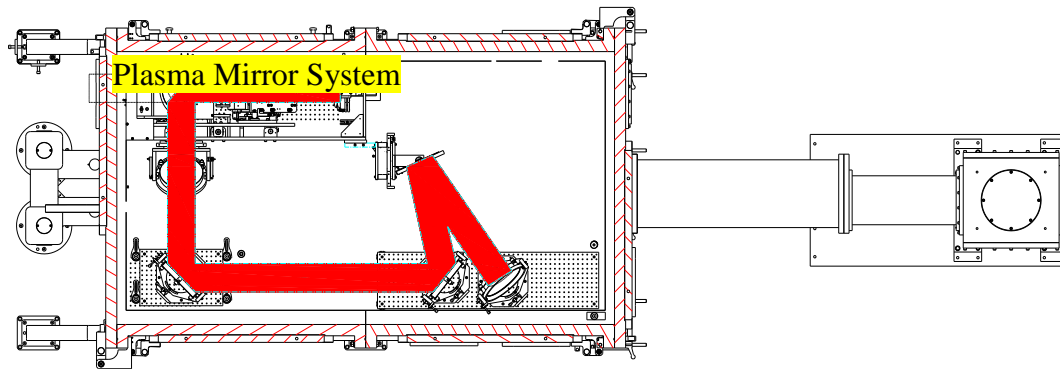

(2) F/2 (South beam) with F/2 (North beam): Small angle or 90 degrees between beams.

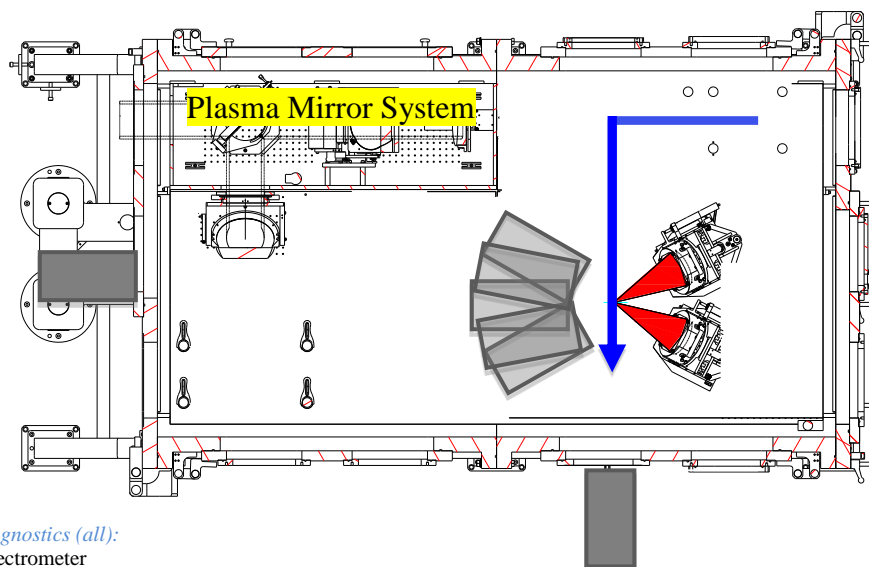

External port diagnostics (all):

- Thomson Ion Spectrometer
- Electron spectrometer
- Flat-field spectrometer
- X-ray crystal spectrometer
- Pinhole camera



Raised level beam transport is shown below to aid planning of out of plane diagnostics.

Note: This diagram shows the space at **high level** in the target chamber which is taken up by beam paths.

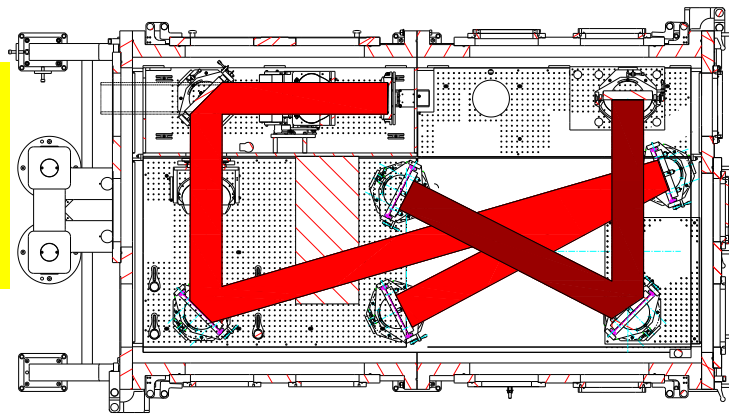

(3) Colliding and collinear geometry

It is possible to arrange the beams with $F/20 + F/20$ focusing with 120 degrees between them, or $F/20$ and $F/2$ (with a 20mm central hole) focusing in co- or counter-propagating geometry. Applicants **must** contact Gemini staff if they are considering either of these options.

(4) F/40 (south beam)

The South beam can be installed with an $F/40$ focusing geometry folded with a periscope. Because it involves operating very close to the damage threshold of the folding optics, please contact Gemini staff if you are interested in using this geometry.

